

**PHILIPS**

**VideoTracer**

Body-worn Recorder

DVT3120



**User manual**

# Table of contents

---

<b>1</b>	<b>Important information</b>	<b>3</b>
	Safety instructions	3
	Cleaning and disinfection	3
	Disposal of your old product	3
	About this user manual	4
	Symbols used	4
<b>2</b>	<b>Your body - worn recorder</b>	<b>5</b>
	Product highlights	5
	What's in the box	5
	Overview of the recorder	6
<b>3</b>	<b>Getting started</b>	<b>8</b>
	Charging the battery	8
	Turn the device on and off	9
	Set the date and time	9
	Set the device language	9
<b>4</b>	<b>Video recording</b>	<b>10</b>
	Recording screen	10
	Record a video	10
	Start and finish a video recording	10
	Zoom function	10
	Night vision	11
	Mark important recordings	11
	Photos	11
<b>5</b>	<b>Audio recording</b>	<b>12</b>
	Recording screen	12
	Record an audio file	12
	Start and finish an audio recording	12
	Mark important recordings	12
	Use the Noise cut feature	12
<b>6</b>	<b>Playback</b>	<b>13</b>
	Playback screen video recordings	13
	Playback screen audio recordings	13
	Playback screen photos	13
	Play back files	14
	Select a file	14
	Start playback	14
	One-touch playback	14
	Mark important files	15
	Delete files	15
<b>7</b>	<b>Settings</b>	<b>16</b>
	Settings mode	16
	Audio recording settings	16
	Video recording settings	16
	Photo settings	17
	Device settings	17
<b>8</b>	<b>Using the camera clip</b>	<b>19</b>
	Attach camera clip	19
	Detach camera clip	19
	How to wear the clip	19
<b>9</b>	<b>Using the magnetic pin</b>	<b>20</b>
	Attach pin	20

---

<b>10</b>	<b>Data management</b>	<b>21</b>
	Transfer data to a computer	21
	Reset your device settings	21
<b>11</b>	<b>Service and support</b>	<b>22</b>
	Display device information	22
	Contact a Philips partner	22
	Troubleshooting	23
<b>12</b>	<b>Technical data</b>	<b>24</b>

# 1 Important information

Don't make any adjustments and modifications that aren't described in this manual. Follow all safety instructions to ensure proper operation of the device. The manufacturer assumes no liability for damages resulting from non-compliance with the safety instructions.

## Safety instructions

- Protect the device from rain and liquids to prevent damage to the device or a short circuit.
- Don't expose the device to excessive heat caused by placing it on a heating device or in direct sunlight.
- Protect the cables from damage by being trapped, particularly at the plugs and where cables exit the housing.
- Back up your data and recordings. The manufacturer's warranty doesn't cover loss of data resulting from user actions.
- Don't perform any maintenance operations that aren't described in this user manual. Don't disassemble the device into its component parts to carry out repairs. The device may only be repaired in authorized service centers.

## Rechargeable built-in battery

- Don't attempt to replace the battery yourself. The battery may only be replaced in authorized service centers.
- Before your battery is replaced by an authorized service center, back up your data and recordings.
- Batteries contain substances that may pollute the environment. Used batteries should be disposed of at an official collection point.

## Data reset

Philips VideoTracer has an internal memory with 16 GB built-in storage. If you want to perform a factory data reset, observe the following cautions:

- Back up your data and recordings. Performing a factory data reset will delete all data on your device.
- Formatting the memory on a computer may cause incompatibilities with your device. Format the memory only on the device.

## Hearing protection

Observe the following guidelines when you use headphones:

- Set the volume to a moderate level and don't use headphones to listen for excessively long periods of time.
- Be particularly careful to avoid adjusting the volume to a level that your hearing can't deal with.

- Don't turn the volume up so high that you can't hear what is going on around you.
- In potentially dangerous situations, be particularly careful or temporarily discontinue use.
- Don't use headphones while you are operating a motorized vehicle, cycling, skateboarding, and so on. You could be a hazard to yourself and other road users, and possibly be breaking the law.

## Legal restrictions on recording

- The use of the device's recording function is subject to the legal restrictions that may apply in your country. You should also respect the privacy and personal rights of third parties if you record talks or lectures.
- If you want to record telephone calls, check if this is legal in your country. In certain countries, you may be legally required to inform the person you are conversing with on the telephone that you are recording the conversation.

## Cleaning and disinfection

- Before cleaning, disconnect all cables from the device.
- To clean the device, use a soft dry cloth.
- To disinfect the device, use products for disinfection of surfaces in clinical areas and patient care equipment, such as surface disinfectant wipes.
- Don't use harsh chemicals or strong detergents.
- Avoid getting moisture in openings.
- Don't rub or strike the surface with anything hard or sharp as this may scratch or damage the surface permanently.

## Disposal of your old product

### Europe

A crossed-out wheeled bin symbol attached to a product indicates that the product is covered by the European Directive 2011/65/EU. Please get informed about the local separate collection system for electrical and electronic products. Please act according to your local rules and don't dispose of your old products with your normal household waste. Correct disposal of your old product helps to prevent potential negative consequences for the environment and human health.



### United States

#### Rechargeable Li-ion battery:

- Your product is designed and manufactured with high quality materials and components, which can be recycled and reused. For recycling information, please contact your local waste management facilities or visit [www.recycle.philips.com](http://www.recycle.philips.com).
- This appliance contains a rechargeable lithium-ion battery which must be disposed of properly.

- Contact your local town or city officials for battery disposal information.  
You can also call 1-800-822-8837 or visit [www.call2recycle.org](http://www.call2recycle.org) for battery drop-off locations.
- For assistance, visit our website [www.philips.com/support](http://www.philips.com/support) or call 1-800-243-3050 toll free.

#### Rechargeable NiMH battery:

- Your product is designed and manufactured with high quality materials and components, which can be recycled and reused. For recycling information, please contact your local waste management facilities or visit [www.recycle.philips.com](http://www.recycle.philips.com).
- This appliance contains a rechargeable NiMH battery which must be disposed of properly.
- Contact your local town or city officials for battery disposal information.  
You can also call 1-800-822-8837 or visit [www.call2recycle.org](http://www.call2recycle.org) for battery drop-off locations.
- For assistance, visit our website [www.philips.com/support](http://www.philips.com/support) or call 1-800-243-3050 toll free.

## Canada

#### Rechargeable Li-ion battery:

- Your product is designed and manufactured with high quality materials and components, which can be recycled and reused. For recycling information, please contact your local waste management facilities or visit [www.recycle.philips.com](http://www.recycle.philips.com).
- This appliance contains a rechargeable lithium-ion battery which must be disposed of properly.
- Contact your local town or city officials for battery disposal information.  
You can also call 888-224-9764 or visit [www.call2recycle.ca](http://www.call2recycle.ca) for battery drop-off locations.
- For assistance, visit our website [www.philips.com/support](http://www.philips.com/support) or call 1-800-243-7884 toll free.

#### Rechargeable NiMH battery:

- Your product is designed and manufactured with high quality materials and components, which can be recycled and reused. For recycling information, please contact your local waste management facilities or visit [www.recycle.philips.com](http://www.recycle.philips.com).
- This appliance contains a rechargeable NiMH battery which must be disposed of properly.
- Contact your local town or city officials for battery disposal information.  
You can also call 888-224-9764 or visit [www.call2recycle.ca](http://www.call2recycle.ca) for battery drop-off locations.
- For assistance, visit our website [www.philips.com/support](http://www.philips.com/support) or call 1-800-243-7884 toll free.

## About this user manual

Find a quick overview of your device on the next pages. For detailed description, see the following chapters of this user manual. Read the instructions carefully.

### Symbols used



Tip

- This symbol identifies information that helps you to use your device more efficiently and simply.



Note

- This symbol indicates notices which you should observe when handling or operating the device.



Caution

- This symbol warns of damage to the device and possible data loss. Damage can be caused by improper handling.

## 2 Your body-worn recorder

We are delighted that you have chosen a Philips device. Visit our website for comprehensive support, such as user manuals, software downloads, warranty information and more: [www.philips.com/dictation](http://www.philips.com/dictation).

### Product highlights

- HD video and audio recording
- Quality night recordings
- Motion detection
- Pre-recording and post-recording
- Built-in GPS
- Water mark with a unique user ID, a time and date stamp
- 170° wide-angle lens
- 2" LCD screen
- Extra long battery life
- Robust and water-resistant design

### What's in the box

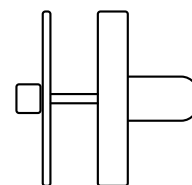
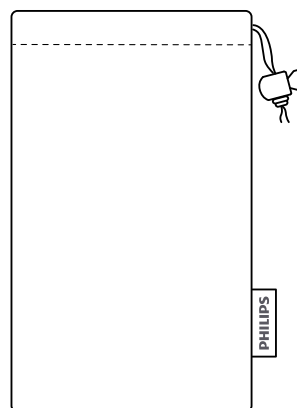
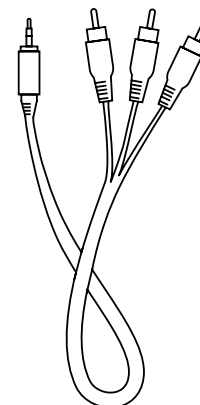
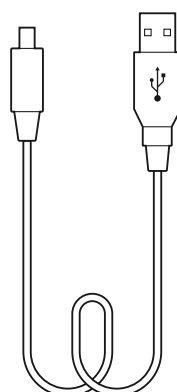
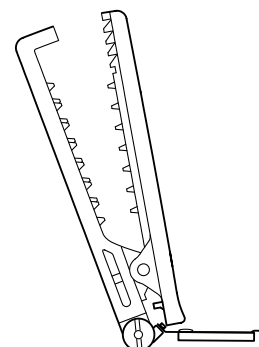
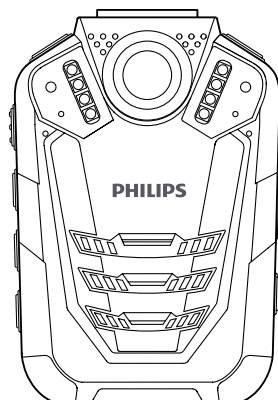

## Overview of the recorder

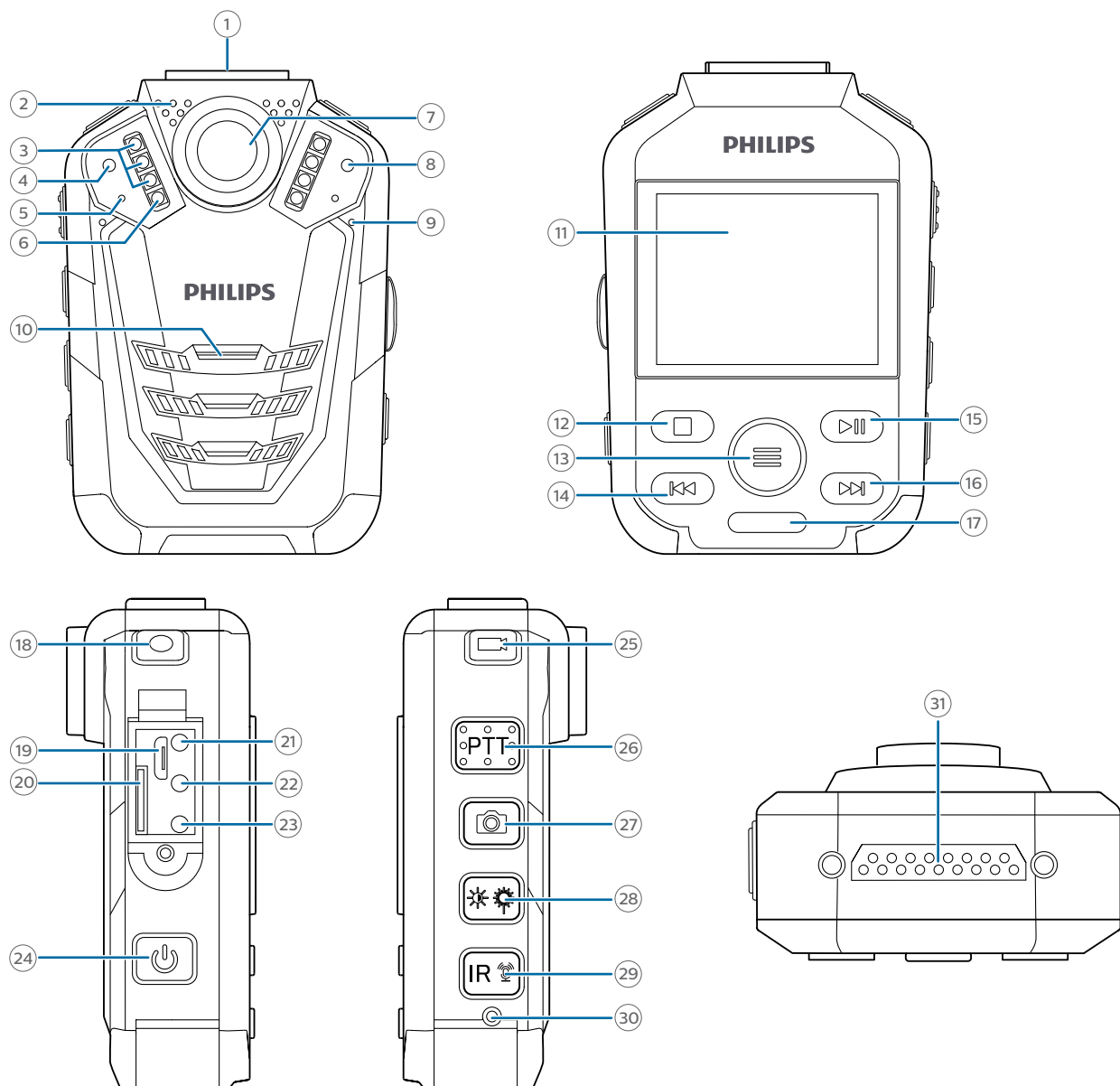

- ① Slot for camera clip
- ② Microphone for radio set (radio set not included)
- ③ Infrared lamp
- ④ Light sensor
- ⑤ Record/Status LED
- ⑥ LED light
- ⑦ Camera lens
- ⑧ Laser light
- ⑨ Microphone
- ⑩ Speaker
- ⑪ Screen
- ⑫ Stop/Return button
- ⑬ Menu button
- ⑭ Fast rewind, Previous track, Navigation button
- ⑮ Play/Pause, Confirmation button
- ⑯ Fast forward, Next track, Navigation button
- ⑰ Notch for pin
- ⑱ Audio recording button
- ⑲ Micro USB port
- ⑳ SD card slot
- ㉑ Headphone jack
- ㉒ AV OUT port

- ②③ AV IN port
- ②④ On/Off button
- ②⑤ Video recording button
- ②⑥ Push-to-talk button for radio set (radio set not included)
- ②⑦ Photo button
- ②⑧ Lighting/Laser button
- ②⑨ Infrared/File marking button
- ③⑩ Reset button
- ③⑪ Interface for docking station (docking station not included)

# 3 Getting started



## Caution

- Before you connect and install your recorder, first read the safety instructions (see [Safety instructions](#)).

## Charging the battery

Charge the built-in battery before you use the device for the first time or if you haven't used it for an extended time period. If the battery is completely discharged and your device turns off, allow the battery to charge for a while before you turn on the device.



## Note

- The length of the USB cable might impact the charging speed. Longer cables usually extend the charging time.
- While the device is connected to a computer, it can't be operated manually.
- If you charge your device via computer instead of using a power supply unit, the charging speed might slow down due to a lower charging current. For fast charging, use a USB power supply unit with at least two ampere (not included).

- 1 Make sure that your computer is turned on. The device can be charged when it's turned on or off.
- 2 Open the closure of the cover on the left side of the device.

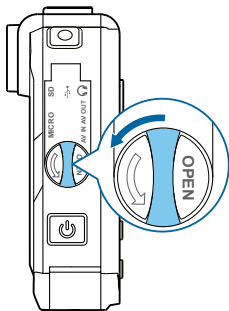

- 3 Lift the cover.

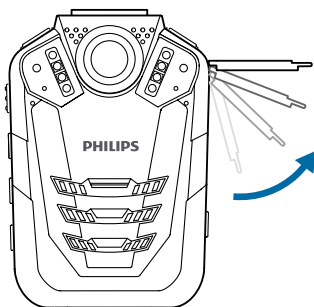

- 4 Connect the VideoTracer to your computer via the supplied USB cable.

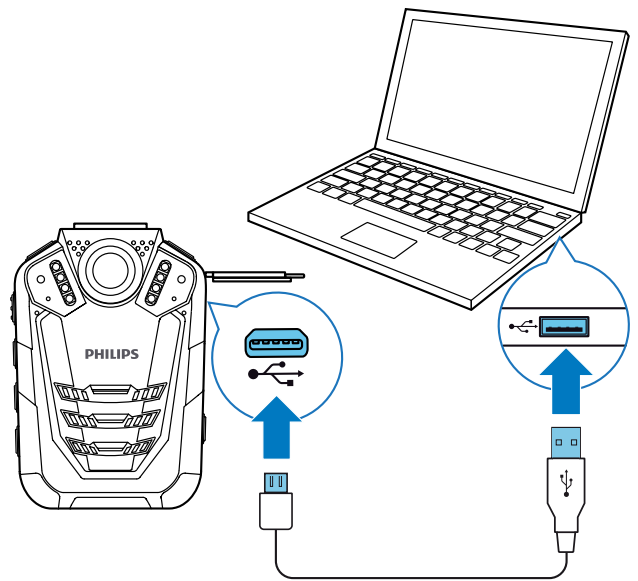

- ↳ A charging battery icon appears on the screen if the VideoTracer is turned on and the Record/Status LED light glows green indicating that the device is recharging.
- ↳ When the device is fully recharged, the Record/Status LED turns off.



---

## Turn the device on and off

To turn the device on or off:

- Press and hold the Power button for two seconds until the device gently vibrates.





### Note

- When the battery indicator  is displayed, charge the device promptly.

---

## Set the date and time



You can always change the date and time as well as the time format on your device.

- 1 On the start screen, press the Menu button  to open the settings screen.
- 2 Press the Menu button  to scroll to the Device settings menu.
- 3 Press the Fast forward button to scroll to the **Date/time** setting, and then press the Play/Pause button to confirm your selection.
- 4 Use the Fast forward, Fast rewind and Menu buttons to set the date and time.
- 5 Press the Play/Pause button to confirm your settings.
- 6 To return to the recording screen, press the Stop button.

---

## Set the device language

You can always change the language of your device.

- 1 On the start screen, press the Menu button  to open the settings screen.
- 2 Press the Menu button  to scroll to the Device settings menu.
- 3 Press the Fast forward button to scroll to the **Language** setting, and then press the Play/Pause button to confirm your selection.
- 4 Press the Fast forward button to scroll to your desired language, and then press the Play/Pause button to confirm your selection.
- 5 To return to the recording screen, press the Stop button.

# 4 Video recording

## Recording screen



- ① Recording mode
- ② Current recording time
- ③ GPS indication
- ④ Night mode
- ⑤ Motion sensor
- ⑥ Noise cut
- ⑦ Resolution
- ⑧ Remaining storage capacity
- ⑨ Battery status
- ⑩ GPS coordinates
- ⑪ Current date of recording
- ⑫ Current time of recording
- ⑬ ID number

## Record a video

### Before you start recording:

- Make sure your device has enough battery power left. When the battery is almost discharged, the battery icon on your display will start flashing red. When the battery is empty, the device will turn off and your current recording will automatically be saved.
- Set the desired preferences for your recording and make a test recording in order to achieve the best recording results. For more information about recording settings, see [Video recording settings](#).

### Note

- Be careful not to cover the microphones while recording. This might result in a lower recording quality.
- Do not remove the memory card while recording. This might result in damaging the recorded file.
- If the recording time of your current recording exceeds the available storage capacity, the recording will stop. In this case, delete files from your device to make more storage available. However, the recording only stops if loop recording is not activated. For more information, see [Video loop](#).

## Start and finish a video recording

- 1 On the start screen, press the Video recording button on the top of the device.
  - ↳ The device vibrates once.
  - ↳ The Record/Status LED light flashes red.
- 2 To finish recording, press the Video recording button on the top of the device again.
  - ↳ The device vibrates twice.
  - ↳ The Record/Status LED light glows green.
  - ↳ The recording is automatically saved to your video recordings folder.

## Zoom function

You can zoom in and out while recording a video.

- To zoom in, press and hold the Fast forward button.
- To zoom out, press and hold the Fast rewind button.

## Night vision

When you are filming at night or in a low-light environment, you can improve the visibility and quality of your video by using the night mode or the additional LED light.

### Activate night mode

- On the start screen or in video recording mode, press and hold the Infrared button.
  - ↳ The screen turns black and white.
- To turn off night mode, press and hold the Infrared button again.

### Turn on LED light

- On the start screen or in video recording mode, press and hold the Lighting/Laser button.
- To turn off the LED light, press and hold the Lighting/Laser button again.

### Turn on laser light

Use the laser light to locate the recording area more easily when video recording at night or in a low-light environment.

- On the start screen or in video recording mode, shortly press the Lighting/Laser button.
- To turn off the laser light, shortly press the Lighting/Laser button again.



#### Caution

- Be careful when pointing at something with the laser light! Laser radiation can be highly damaging for your eyes. Avoid any eye exposure to direct radiation!

## Mark important recordings

You can mark important recordings in order to prevent them from being deleted by loop recording.

- During recording, shortly press the Infrared button.
  - ↳ An orange star appears in the bottom right corner of the recording.



#### Tip

- You can also mark the recording after you have finished recording. For more information, see [Mark important files](#).

## Photos

You can take pictures of an event while video recording.

- Press the Photo button while recording.
  - ↳ The picture is saved to your image folder.



#### Note

- Use the night mode or the additional LED light when taking photos in a low-light environment. For more information, see [Night vision](#).

# 5 Audio recording

## Recording screen

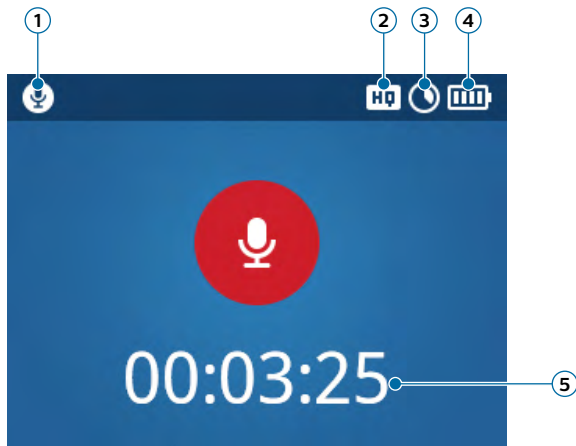

- ① Recording mode
- ② Recording quality
- ③ Current memory card capacity
- ④ Battery status
- ⑤ Audio time

## Record an audio file

### Before you start recording:

- Make sure your device has enough battery power left. When the battery is almost discharged, the battery icon on your display will start flashing red. When the battery is empty, the device will turn off and your current recording will automatically be saved.
- Set the desired preferences for your recording and make a test recording in order to achieve the best recording results. For more information about recording settings, see [Audio recording settings](#).



### Note

- Be careful not to cover the microphones while recording. This might result in a lower recording quality.
- Do not remove the memory card while recording. This might result in damaging the recorded file.
- If the recording time of your current recording exceeds the available storage capacity, the recording will stop. In this case, delete files from your device to make more storage available.

## Start and finish an audio recording

- 1 On the start screen, press the Audio recording button on the top of the device.
  - ↳ The device vibrates once.
  - ↳ The Record/Status LED flashes orange.
- 2 To finish recording, press the Audio recording button on the top of the device again.
  - ↳ The device vibrates once.
  - ↳ The Record/Status LED glows green.
  - ↳ The recording is automatically saved to your audio recordings folder.

## Mark important recordings

You can mark important recordings in order to prevent them from being deleted by loop recording.

- During recording, shortly press the Infrared button.
  - ↳ An orange star appears in the bottom right corner of the recording.



### Tip

- You can also mark the recording after you have finished recording. For more information, see [Mark important files](#).

## Use the Noise cut feature

Turn the Noise cut feature on in order to reduce background noise while recording. This way, especially audio recordings sound clearer. You can activate the Noise cut feature in the audio recording settings in the Settings menu.



### Note

- When Noise cut is enabled, you will see **NC** on the top of the starting screen.

# 6 Playback

## Playback screen video recordings

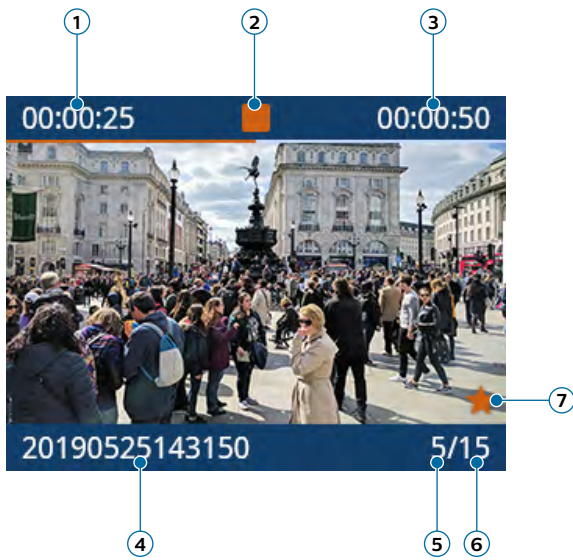

- ① Passed playback time
- ② Playback status
- ③ Total time of recording
- ④ File name
- ⑤ File number of current file
- ⑥ Total number of files in folder
- ⑦ Marker for important recording

## Playback screen audio recordings

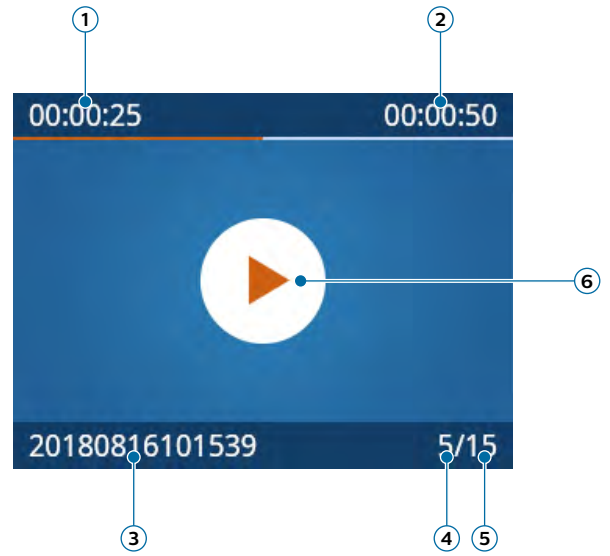

- ① Passed playback time
- ② Repeat mode
- ③ File name
- ④ File number of current file
- ⑤ Total number of files in folder
- ⑥ Playback status

## Playback screen photos

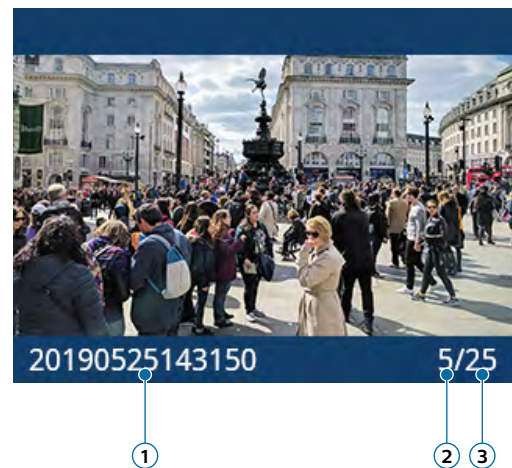

- ① File name
- ② File number of current file
- ③ Total number of files in folder

## Play back files



### Note

- If you have connected headphones to your VideoTracer, the built-in speakers are disabled.

### Select a file

- 1 On the start screen, press the Play/Pause button.  
↳ The folder overview is displayed.

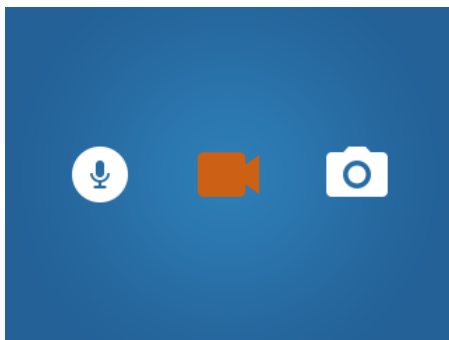

- 2 Use the Fast forward and Fast rewind buttons to select one of the following folders: audio recordings, video recordings or images.
- 3 Press the Play/Pause button to enter the desired recordings folder.  
↳ All files in the folder are displayed.
- 4 Use the Fast forward and Fast rewind buttons to select a recording or image, and then press the Play/Pause button to open the recording or image.
- 5 To play back an audio or a video recording, press the Play/Pause button. To pause playback, press the Play/Pause button again.



### Tip

- You can control the playback volume by pressing the Menu button .

- 6 To return to the previous screen, press the Stop button once. To return to the start screen, press the Stop button three times.



### Note

- A maximum of nine files is displayed on one page of a folder. If your folder contains more than nine files, you have to scroll to the next page by using the Fast forward button. The number of the current file and the existing files is displayed in the bottom right corner of the file list screen.
- You can also switch between the files in stop mode on the playback screen.

## Start playback

- 1 Select your desired file as described in [Select a file](#).
- 2 To start playback of a recording, press the Play/Pause button.  
To pause playback, press the Play/Pause button again.
- 3 To adjust the volume, press the Menu button  and then press the Fast forward button for volume up or the Fast rewind button for volume down.  
↳ The volume display will disappear after eight seconds.
- 4 To stop playback and return to the file list, press the Stop button.

### Fast rewind or fast forward (only video recordings)

- In playback mode, press the Fast rewind or Fast forward button to the desired part of the recording and then press the Play/Pause button.



### Tip

- If you press the fast forward button twice or more, you can increase the playback speed by up to 64 times.

## One-touch playback

You can play back your recorded file immediately after finishing recording with only one touch.

- 1 Record your file as described in [Start and finish a video recording](#) or [Start and finish an audio recording](#).
- 2 Immediately after finishing recording, press the Stop button once.  
↳ Playback of the last recorded file will start.

---

## Mark important files

You can mark important recordings and images in order to prevent them from being deleted by loop recording.

- 1 Select and open your desired file as described in [Select a file](#).
- 2 Press the Infrared button to mark the recording.
  - ↳ An orange star appears in the bottom right corner of the recording.

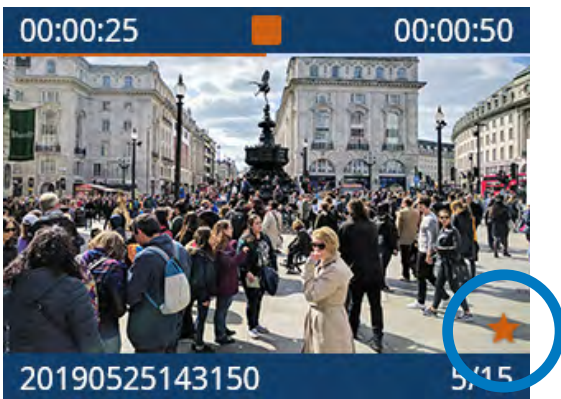

---

## Delete files

You can only delete files from your VideoTracer in the file manager on your computer. It is not possible to delete files directly on the device.

- 1 Turn your VideoTracer on and connect the device to the computer via the supplied micro USB cable.
  - ↳ A charging battery icon appears on the screen.

### Note

- Make sure that VideoTracer is turned on or otherwise it will not be recognized by your computer!

- 2 Open Windows Explorer on a Windows computer, or open Finder on a Mac computer.
  - ↳ VideoTracer is recognized as an external drive.
- 3 Double-click the VideoTracer drive.
  - ↳ The content of your VideoTracer is displayed in a new window.
- 4 Select the files that need to be deleted, right-click on the files and then click **Delete**.

# 7 Settings

## Settings mode

In the settings mode, you can change and adjust various settings according to your own preferences.

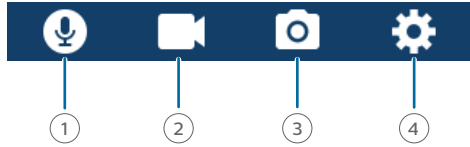

- ① Audio recording settings
- ② Video recording settings
- ③ Photo settings
- ④ Device settings

### Start the settings mode

- On the start screen, press the Menu button

### Switch between settings menus

- Press the Menu button

### Scroll through settings of each settings menu

- Use the Fast forward or Fast rewind button.

### Select a setting or confirm a selection

- Press the Play/Pause button.

### Return to settings screen

- In the sub-menu screen, press the Stop button.

### Exit the settings mode and return to start screen

- In the settings overview, press the Stop button.

## Audio recording settings



### Quality

You can set the bit rate for each recording according to your own preferences.

### Mic sensitivity

Adjust the microphone sensitivity of your VideoTracer. Select the sensitivity according to the background noise and distance between sound source and microphone.

### Noise cut

Turn the Noise cut feature on in order to reduce background noise while recording. This way, especially audio recordings sound clearer.

## Video recording settings



### Resolution

Select the resolution of your video recording.



Note

- The higher the resolution, the larger the recording file will be and the more memory space will be required.

### Quality

Select the quality of your video recording.



Note

- The higher the quality, the larger the recording file will be and the more memory space will be required.

### In-car Mode

Activate the In-car Mode to use your VideoTracer in the car. You can either record with or without audio sound. When the In-Car Mode is activated and the device is connected to the charger in your car, the device automatically starts recording. When the charger is disconnected, the recording will automatically be saved and the device will turn off.

### Video loop

When this function is enabled, the device will automatically delete the very first recording in the recordings list when the available memory capacity is 400 MB or less, and then continue recording.



## Pre-recording

When the pre-recording function is enabled, the device will start recording a video some seconds prior to the event. At maximum resolution (2304 × 1296 px at 30 fps), pre-recording starts 20 seconds before the event. At lowest resolution (848 × 480 px at 25 fps), pre-recording starts 50 seconds prior to the event.

### Note

- Pre-recording consumes additional battery power. Make sure that you have enough battery power left if you use this feature.

## Post-recording

When this function is enabled, you can keep recording for a set time interval after finishing the recording. Post-recording will automatically start after you have stopped the recording.

## Photo settings



### Resolution

Select the resolution of your photos.

### Note

- The higher the resolution, the larger the recording file will be and the more memory space will be required.

### Quality

Select the quality of your photos.

### Note

- The higher the quality, the larger the recording file will be and the more memory space will be required.

### EV

When you select the EV (exposure value) setting, you can adjust the brightness of your photos.

### Burst shots

You can select the number of photos that are taken sequentially when pressing the Camera button on the start screen.

### Timer

With the timer function, you can select a pre-run time before a photo is taken. When you press the Photo button, the timer will start counting down automatically.

## Device settings



### Language

Select your desired device language from the language list. You can change the language whenever you want.

### TV Mode

Select if you want to use NTSC or PAL standard when connecting your VideoTracer to a TV for playback of video recordings.

### Reset device

You can reset your menu settings to their default state—the way they were when you first purchased your device and turned it on. For more information, see [Reset your device settings](#).



### Caution

- Resetting your menu settings will delete all settings you have made on your device. After a reset, you will have to adjust all settings again.



### Note

- Your data won't be deleted and is still available after resetting the menu settings.

### LCD brightness

Adjust the brightness of your screen according to your own requirements.

### Date/time

You can always change the system date and time on your device. Use the Fast forward, Fast rewind and Menu buttons to set the date and time.

### Auto off

Select a time for your device to automatically turn off when you don't operate it.

### LCD auto off

Select a time for your screen to automatically turn off when you don't operate it.

### Volume

Set the volume for playback of your video and audio recordings. You can also control the volume during playback by pressing the Menu button

## Auto divide

During recording, the auto-divide feature will automatically split the current recording and save a new file at the time interval you have pre-selected.



### Note

- Additionally to your pre-selected time interval for the auto-divide feature, the device will automatically save your recording every hour.

## System sounds

Select if you want the device sounds, such as key tone and power on/off sound, to be turned on or off.

## Record beep

Select if you want to hear a record beep whenever you start and finish a recording.

## Indicator light

Select if you want the Record/Status LED to be turned on or off during recording.

## Night Mode

Select if you want to manually activate the Night Mode or if the device should start this mode automatically when in low-light environments.

## Motion sensor

Activate motion detection to automatically start video recording as soon as an object is moving in front of the lens.



### Note



- After activating the motion sensor, you must first press the Video recording button to enable recording. The recording will then only start when an object enters the lens area.

## GPS

Activate GPS to add GPS coordinates to your photos. The coordinates are displayed on the playback screen when you view the photo in playback mode. You can also see the coordinates in Windows File Explorer when you connect your VideoTracer to a computer.



### Note

- To receive a good GPS signal, we recommend using the device in an outside area.
- When the device is searching for a GPS signal, the GPS search symbol flashes on the screen . When a GPS signal has been received, the GPS symbol is displayed on the screen .

## ID Number

Set the ID number of your VideoTracer, which identifies your device. Your ID number is helpful for support enquiries, for example.

## Information

See various information about your device, such as the available memory space, remaining recording time, or the firmware version.

## 8 Using the camera clip

Use the supplied camera clip to attach your VideoTracer to your clothes.

### Attach camera clip

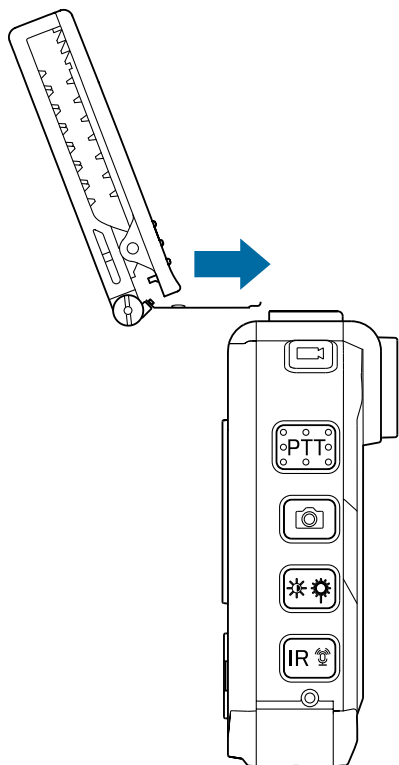

### How to wear the clip

1

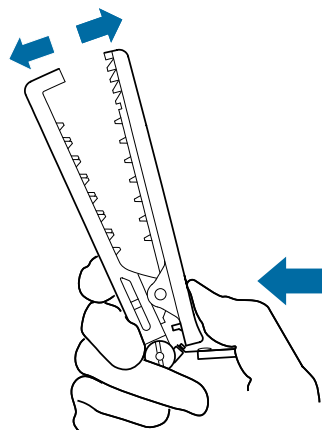

2

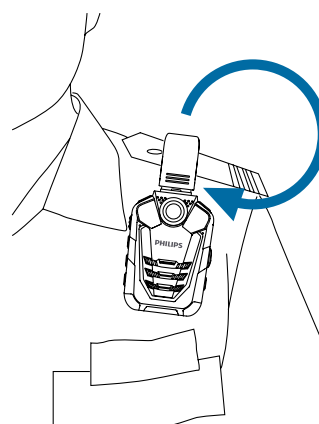

### Detach camera clip

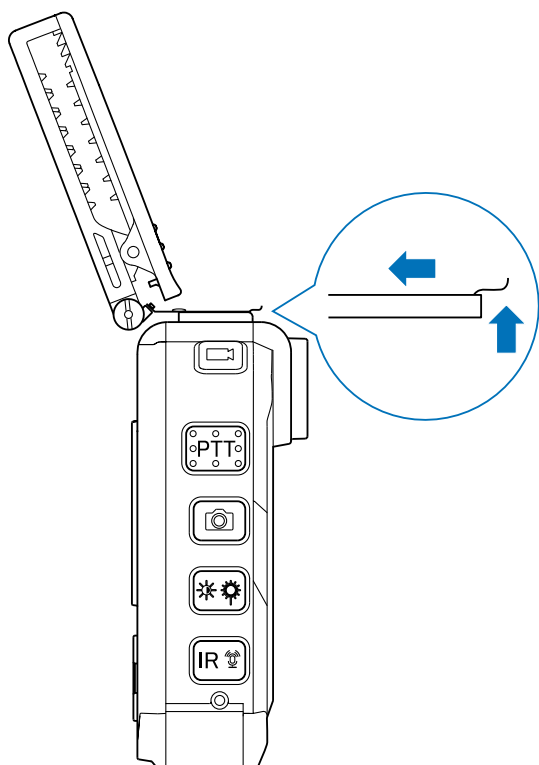

## 9 Using the magnetic pin

---

Use the supplied magnetic pin additionally to the camera clip to allow even firmer attachment of your VideoTracer.

---

### Attach pin

1

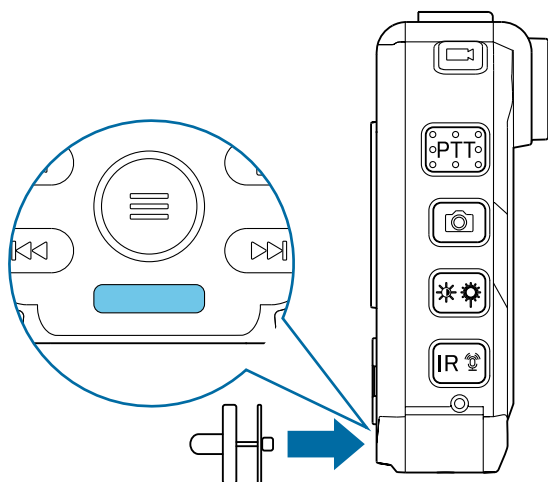

2

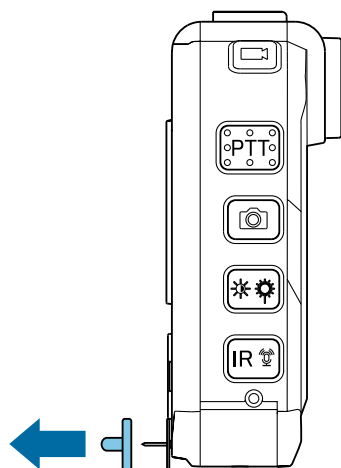

# 10 Data management

## Transfer data to a computer

You can use your recorder as a USB mass storage to conveniently store, back up and move files. Link the device to a computer with a USB cable. Your recorder will automatically be recognized as a mass storage device. You don't need to install any software. For more information on how to connect your device to a computer, see the illustration in [Charging the battery](#).

### Caution

- Don't disconnect the USB cable from the device while you are transferring files. This might cause data loss.

### Note

- Make sure your VideoTracer is turned on if you want to move files from the device to the computer.
- While the device is connected to a computer, it can't be operated manually.

## Transfer data from VideoTracer to the computer

- 1 Make sure your VideoTracer is turned on and connect the device to the computer via the supplied micro USB cable.
  - ↳ A charging battery icon appears on the screen and the Record/Status LED glows green.
- 2 Open Windows Explorer on a Windows computer, or open Finder on a Mac computer.
  - ↳ VideoTracer is recognized as an external drive.
- 3 Double-click the VideoTracer drive.
  - ↳ The content of your VideoTracer is displayed in a new window.
- 4 Select the desired files in the **FILE** folder, and copy, cut or drag them to the desired location on your computer.

## Reset your device settings

You can reset your menu settings to their default state—the way they were when you first purchased your device and turned it on.



### Caution

- Resetting your menu settings will delete all settings you have made on your device. After a reset, you will have to adjust all settings again.

### Note

- Your data won't be deleted and is still available after resetting the menu settings.

### To reset your settings:

- 1 On the start screen, press the Menu button  to open the settings screen.
- 2 Press the Menu button  to scroll to the Device settings menu.
- 3 Press the Fast forward button to scroll to the **Reset device** setting. Press the Play/Pause button to confirm your selection.
- 4 Select **Yes**.
  - ↳ The device automatically reboots.
  - ↳ All settings on your device are reset to their default state.

# 11 Service and support



---

Don't perform any maintenance operations that aren't described in this user manual. Don't disassemble the device into its component parts to carry out repairs. The device may only be repaired in authorized service centers.

---

## Display device information

See various information about your device, such as the available memory space, the remaining video and audio time, or the firmware version.

- 1 On the start screen, press the Menu button  to open the settings screen.
- 2 Press the Menu button  to switch to the Device settings menu.
- 3 Press the Fast forward button to scroll to the **Information** setting. Press the Play/Pause button to confirm your selection.
- 4 Press the Fast forward button to switch to the next page.

---

## Contact a Philips partner

If you have any questions about your VideoTracer or experience technical issues, contact one of our supporting Philips partners. The local partner you purchased your VideoTracer from will strive to answer your questions and to solve your problem as soon as possible.

## Troubleshooting

Find the most common problems you could encounter with your VideoTracer in the following table. If you are unable to solve the problem with the information below, contact the supporting Philips partner you purchased your device from.

Problem	Possible cause	Solution
The device doesn't turn on.	<ul style="list-style-type: none"> <li>The battery has run out of power.</li> </ul>	<ul style="list-style-type: none"> <li>Charge the device for a while and then turn it on again.</li> </ul>
I can't record with the device.	<ul style="list-style-type: none"> <li>You have reached the maximum file number or the device's memory is full.</li> </ul>	<ul style="list-style-type: none"> <li>Delete some files or move them to an external device.</li> </ul>
The device doesn't respond.	<ul style="list-style-type: none"> <li>There is a problem with the software.</li> </ul>	<ul style="list-style-type: none"> <li>Try to turn the device off and then restart it.</li> <li>If you can't turn the device off, reset the device by pressing the Reset button. For more information, see the illustration in <a href="#">Overview of the recorder</a>. Resetting the device won't delete any settings or data.</li> </ul>
The device doesn't play back recordings.	<ul style="list-style-type: none"> <li>The volume is off or too low.</li> </ul>	<ul style="list-style-type: none"> <li>Turn on or turn up the volume.</li> </ul>
I can't hear anything from the speakers.	<ul style="list-style-type: none"> <li>The headphones are connected to the device.</li> <li>The volume is off or too low.</li> </ul>	<ul style="list-style-type: none"> <li>Unplug the headphones.</li> <li>Turn on or turn up the volume.</li> </ul>
I can't hear anything from the headphones.	<ul style="list-style-type: none"> <li>The volume is off or too low.</li> <li>The headphones aren't connected properly.</li> <li>The headphones are connected to the wrong jack (i.e. external microphone jack).</li> </ul>	<ul style="list-style-type: none"> <li>Turn on or turn up the volume.</li> <li>Disconnect the headphones and connect them to the headphones jack again.</li> <li>Disconnect the headphones and connect them to the headphones jack.</li> </ul>
The picture or video quality is poor.	<ul style="list-style-type: none"> <li>The camera lense is dirty.</li> </ul>	<ul style="list-style-type: none"> <li>Clean the camera lense with a soft, dry cloth.</li> </ul>
The quality of audio recordings is too low or there's too much background noise in my audio recordings.	<ul style="list-style-type: none"> <li>The microphone sensitivity is set too high.</li> </ul>	<ul style="list-style-type: none"> <li>Change the microphone sensitivity to medium or low. For more information, see <a href="#">Mic sensitivity</a>.</li> </ul>

# 12 Technical data

---

## Device

- Product dimensions (W × D × H): 61 × 91 × 34 mm (2.4 × 3.6 × 1.3 inches)
- Weight: 180 g (6.2 oz.)

## Connectivity

- Headphones: Stereo jack, 2.5 mm
- AV in: 2.5 mm
- AV out: 2.5 mm
- USB: micro USB 2.0
- MicroSD card socket: up to 128 GB

## Display

- Type: LCD color display
- Diagonal screen size: 5.1 cm (0.6 inches)
- Resolution: 320 × 240 px

## Video recording

- Chipset: Ambarella A7LA50
- Sensor: 5 MP CMOS sensor
- Viewing angle: 170 degrees
- Video resolution: 2560 × 1080 px (21:9)
- 25/30 fps, 2304 × 1296 px (16:9) 25/30 fps,
- 1920 × 1080 px (16:9) 25/30 fps, 1280 × 720 px
- (16:9) 25/30/50/60 fps, 848 × 480 px (16:9)
- 25/30/50/60 fps
- Video encoding: H.264
- Video format: MPEG4
- Loop recording
- Automatic file split: 5 / 10 / 15 / 20 / 30 minutes
- Pre-recording function: max. 50 seconds
- Post-recording function: 5 / 10 / 15 / 30 / 60 seconds
- Motion detection: low, medium, high
- Car DVR mode

## Night recording

- Infrared light: 6 IR LEDs
- Flash light: 2 LEDs
- Up to 6 meters with visible face image

## Audio recording

- Built-in microphone
- Audio format: WAV
- Recording mode: HQ (1536 kbps), SLP (385 kbps)
- Microphone sensitivity: low, medium, high
- Noise cut

## Photo capturing

- Image size: 32 MP, 23 MP, 20 MP, 18 MP, 16 MP, 14 MP, 12 MP, 8 MP, 5 MP, 3 MP
- Image format: JPEG
- Photo quality: super fine, fine, normal
- Burst shots: 3 / 5 / 10 / 20 photos in a row
- Self-timer: 3 / 5 / 10 / 30 / 60 seconds
- EV correction

## Memory

- Memory card (external): microSD card up to 128 GB

## Security

- File tagging with GPS coordinates
- Water mark: user ID, time and date stamp embedded in video
- Unique user ID: 5-digit device ID and 6-digit personal ID
- Auto-divide function to prevent corruption of video files caused by erroneous operation
- Recordings can only be deleted on the computer via USB cable.

## Power

- Battery type: Li-polymer built-in battery
- Battery capacity: 3400 mAh
- Battery lifetime: 9.2 hours (848 × 480 px), 9 hours (1280 × 720 px), 8.4 hours (1920 × 1080 px), 8.2 hours (2560 × 1080 px), 7.2 hours (2304 × 1296 px)
- Charging time (full charge): approx. 5 hours

## Green specifications

- Compliant to 2011/65/EU (RoHS)

## Operation conditions

- Temperature: 5°–45°C
- Humidity: 10% – 90%, non-condensing
- IP67 water and dust resistance

## System requirements

- Operating System: Windows, macOS
- Free USB port



---

## FCC Warning Statement



Changes or modifications not expressly approved by the party responsible for compliance could void the user's authority to operate the equipment.

This equipment has been tested and found to comply with the limits for a Class B digital device, pursuant to Part 15 of the FCC Rules. These limits are designed to provide reasonable protection against harmful interference in a residential installation. This equipment generates uses and can radiate radio frequency energy and, if not installed and used in accordance with the instructions, may cause harmful interference to radio communications. However, there is no guarantee that interference will not occur in a particular installation. If this equipment does cause harmful interference to radio or television reception, which can be determined by turning the equipment off and on, the user is encouraged to try to correct the interference by one or more of the following measures:

- Reorient or relocate the receiving antenna.
- Increase the separation between the equipment and receiver.
- Connect the equipment into an outlet on a circuit different from that to which the receiver is connected
- Consult the dealer or an experienced radio/TV technician for help.

Neither Speech Processing Solutions GmbH nor its affiliates shall be liable to the purchaser of this product or third parties with respect to claims for damages, losses, costs or expenses incurred by purchaser or third parties as a result of an accident, misuse or abuse of this product or unauthorized modifications, repair, modification of the product or failure to meet the operating and maintenance instructions provided by the manufacturer.

MPEG Layer-3 audio coding technology licensed from Fraunhofer IIS and Thomson Licensing.

This user manual is a document with no contractual nature. We accept no liability for changes, mistakes or printing errors.





Issue date 2021-07-07  
Version 1.1

© 2021 Speech Processing Solutions GmbH. All rights reserved.

Specifications are subject to change without notice. Philips and the Philips shield emblem are registered trademarks of Koninklijke Philips N.V. and are used by Speech Processing Solutions GmbH under license from Koninklijke Philips N.V. All trademarks are the property of their respective owners.

[www.philips.com/dictation](http://www.philips.com/dictation)